

# FOR SALE

## Multi-Family Portfolio

4 Buildings | 37 Residential Units



## Multi-Family Portfolio

9-11 Hunt Street, 138 Highland Street,  
252 Woodford Street & 278 Woodford Street

Portland, ME

- **4 Buildings**
- **37 Residential Units**
- **3 Studios, 32 One-Bedrooms, and 2 Two-Bedrooms**
- **Off-Street Parking**

### BROKER CONTACT

TC Haffenreffer | [tc@dunhamgroup.com](mailto:tc@dunhamgroup.com) | 207.956.0091  
207.773.7100 | [dunhamgroup.com](http://dunhamgroup.com)



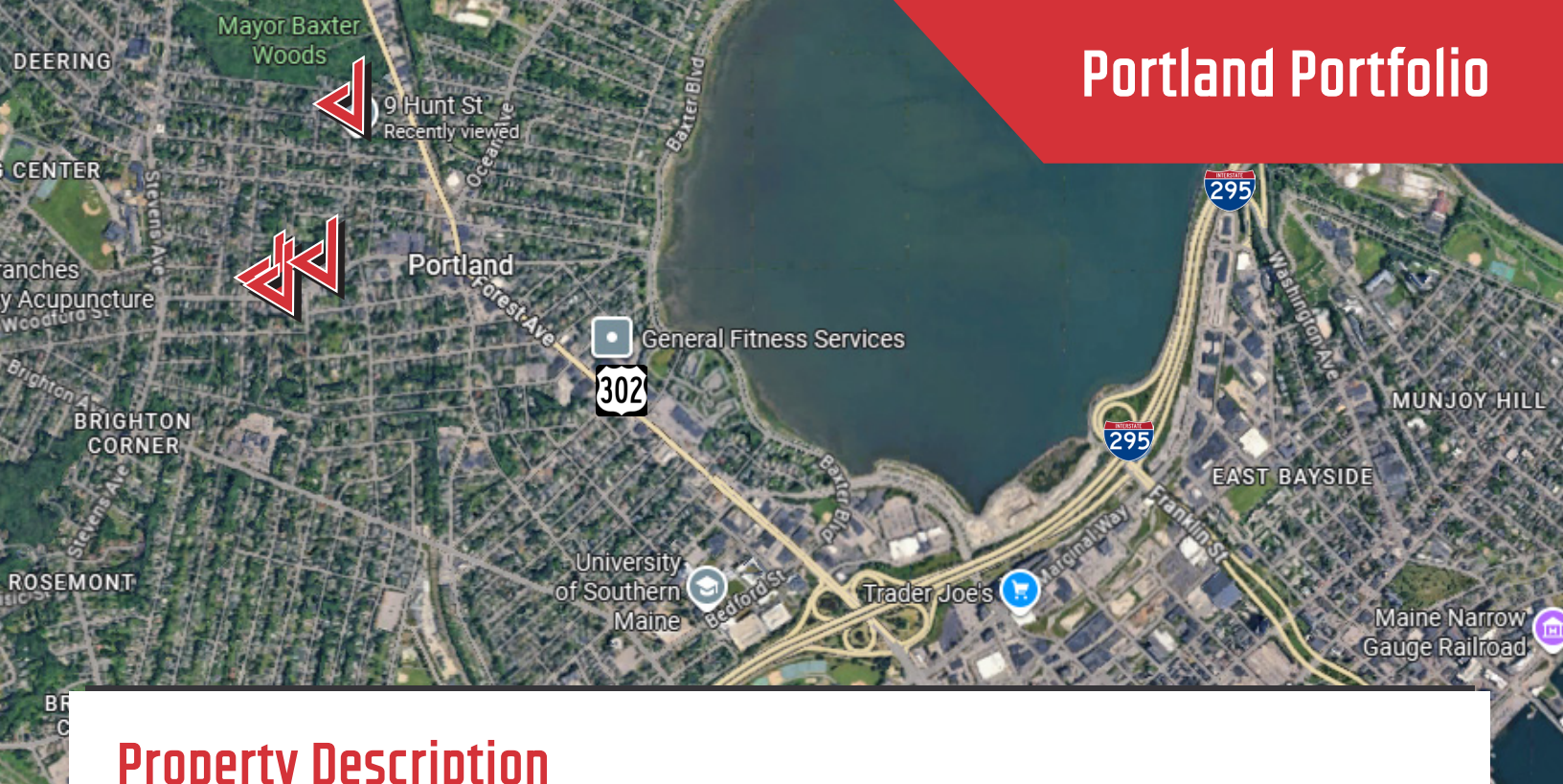

## Property Description

We are pleased to offer this 4 building, 37 unit Multi-Family Portfolio for sale in Portland, Maine. This Hunt/Highland/Woodford Street Portfolio is well-located, just off Forest Avenue/Route 302 and is minutes to I-295 and Downtown. All of the buildings are fully leased and have strong rental histories. The 37 total units consist of 3 studio apartments, 32 one-bedroom and 2 two-bedroom apartments.

Financial information is available with a signed NDA. Please see broker for details.

## Unit Breakdown : 37 Residential Units

- 9-11 Hunt Street: 10 Units (8 one-bedrooms & 2 two-bedrooms)
- 138 Highland Street: 6 Units (6 one-bedrooms)
- 252 Woodford Street: 7 Units (7 one-bedrooms)
- 278 Woodford Street: 14 Units (3 studios, 11 one-bedrooms)

**FOR SALE : SEE BROKER**



# 9-11 Hunt Street

## 9-11 Hunt Street, Portland

Owner	Woodford Hunt Properties, LLC
Building Size	11,428± SF, 3-stories
Lot Size	0.23± acres
Unit Breakdown	10 Residential Units 8 One-Bedrooms & 2 Two-Bedrooms
Assessor's Reference	Map 130, Block I, Lot 2
Annual Taxes	\$17,448 (25-26)
Zoning	Residential (R5)
Year Built	1910
Construction	Woodframe, vinyl siding?, asphalt shingles, full basement?
Utilities	Public water and sewer
HVAC	High efficiency heating system (2023)
Parking	Off street



# 9-11 Hunt Street

9/11/13 Hunt Street, Apt. #9

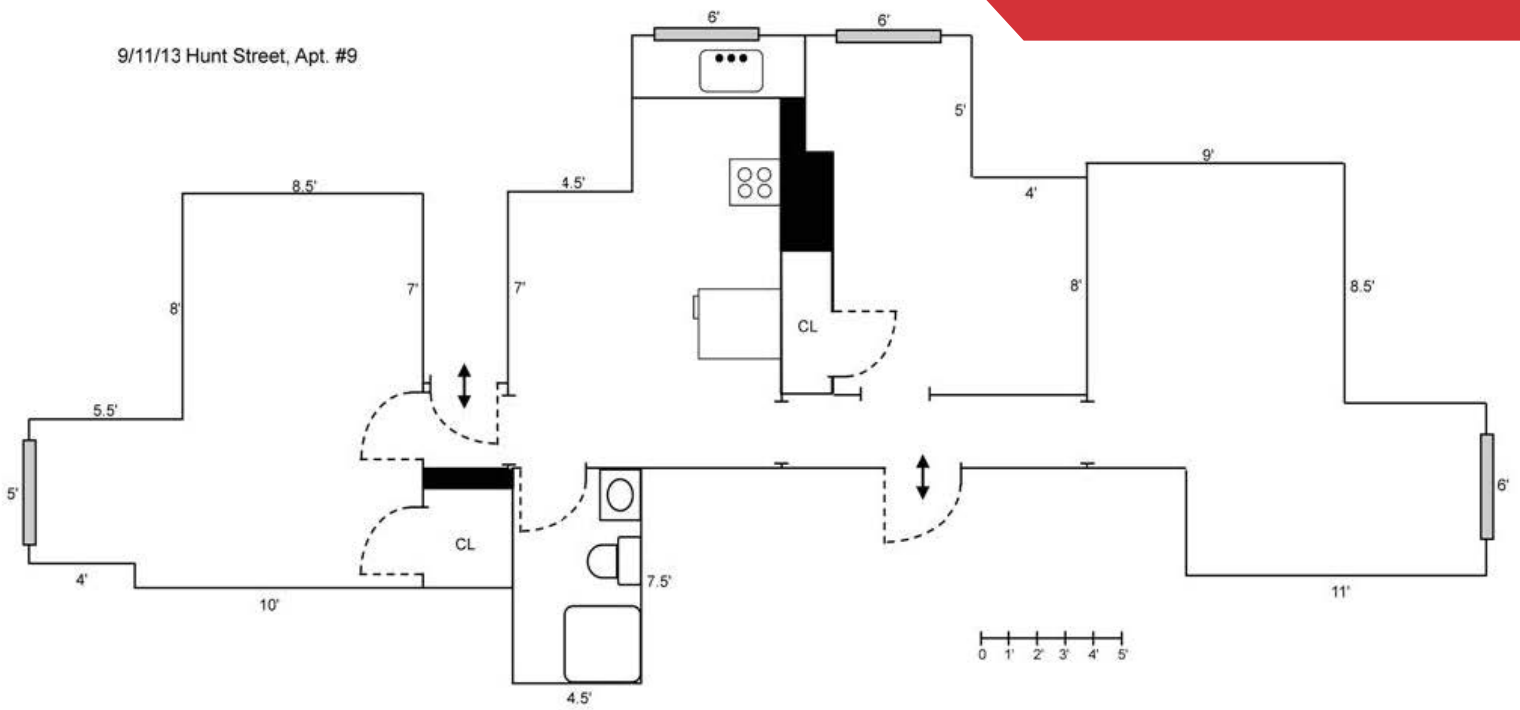

# 9-11 Hunt Street

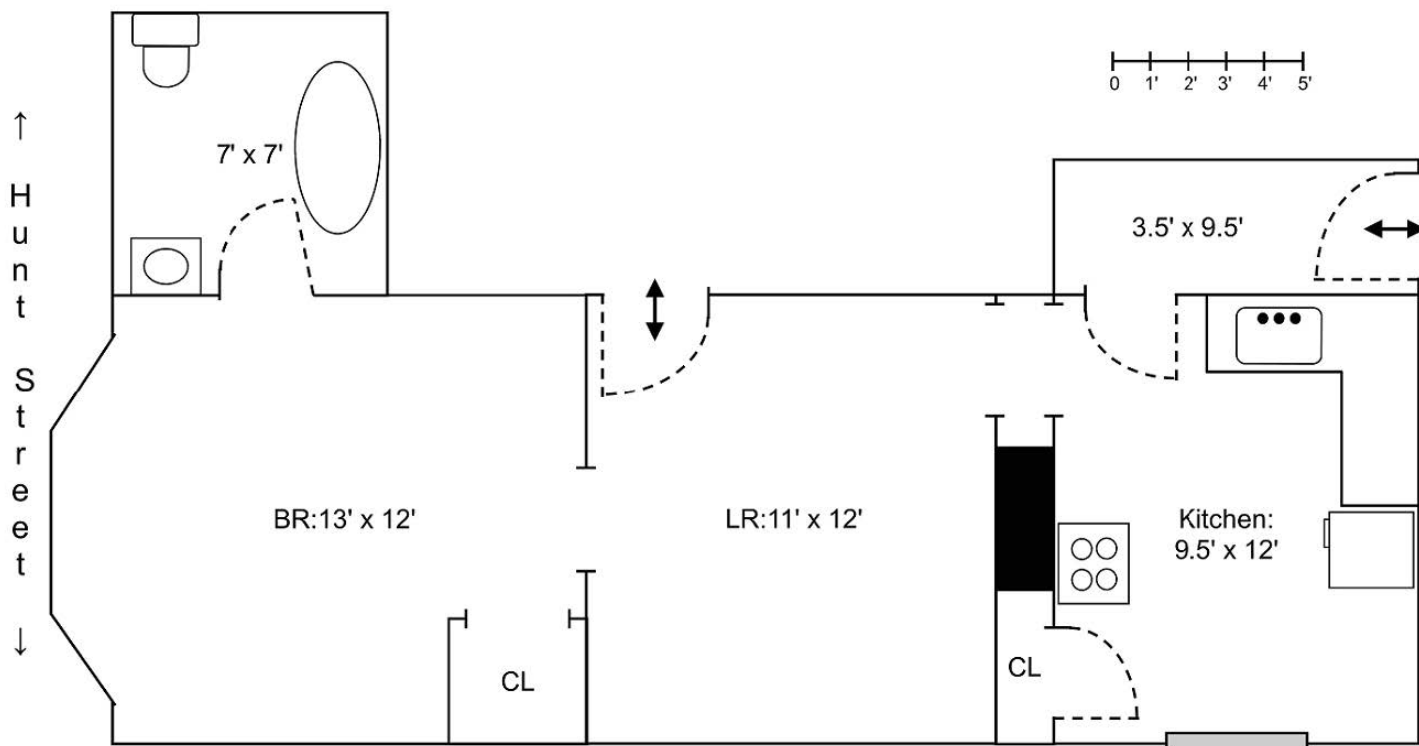
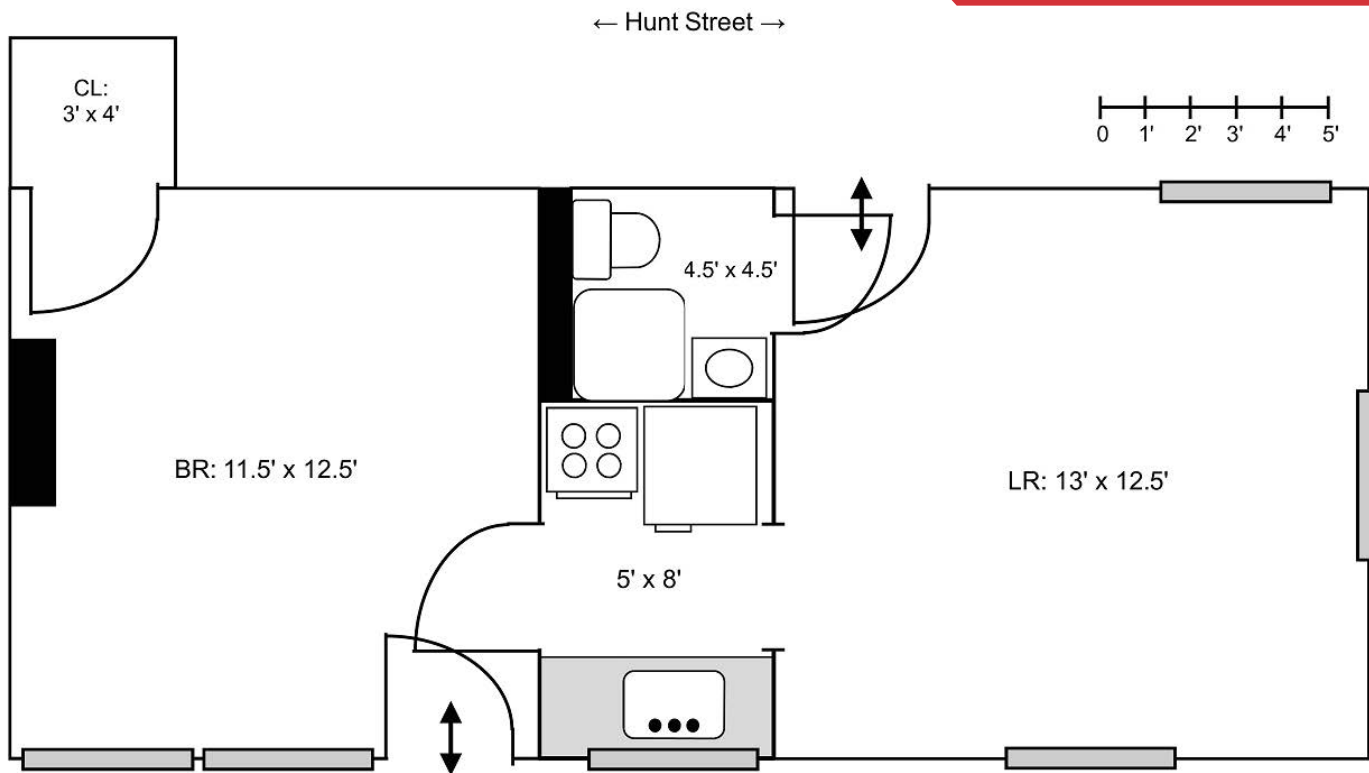

# 138 Highland Street



## 138 Highland Street, Portland

Owner	Woodford Hunt Properties, LLC
Building Size	6,848± SF, 3-stories
Lot Size	0.06± acres
Unit Breakdown	6 Residential Units All One-Bedrooms
Assessor's Reference	Map 123, Block F, Lot 21
Annual Taxes	\$10,952.12 (25-26)
Zoning	Neighborhood Business (B1)
Year Built	1910
Construction	Woodframe, vinyl siding?, rubber membrane roof?, full basement?
Utilities	Public water and sewer, natural gas
HVAC	Natural gas
Parking	Off street

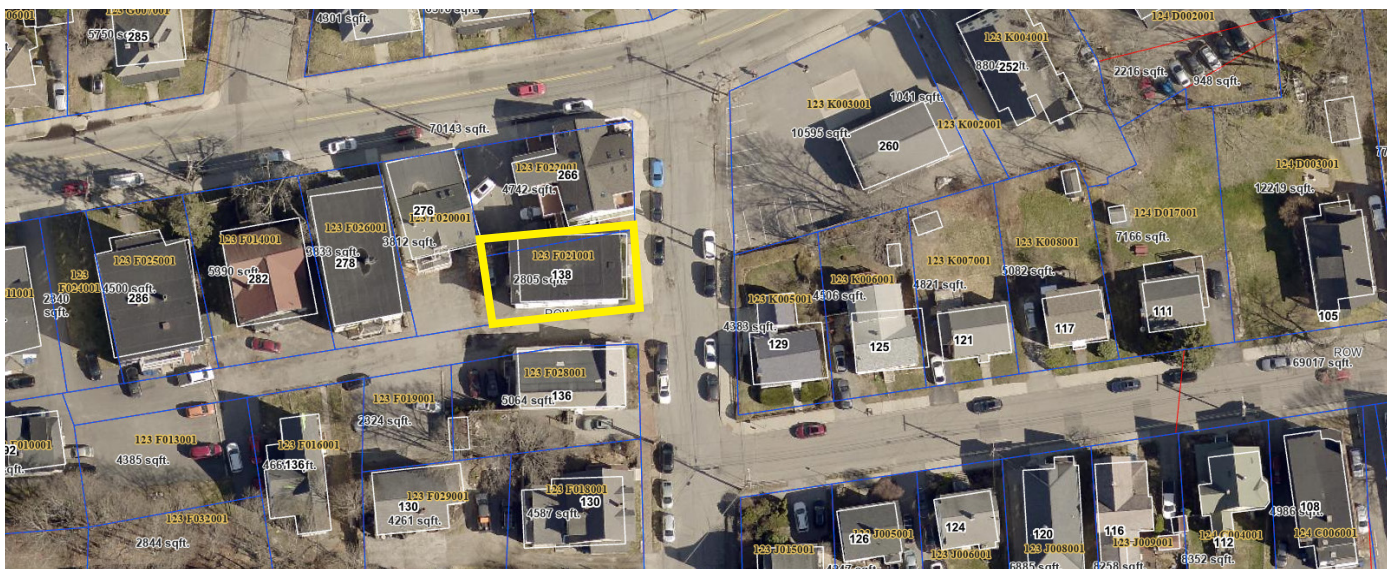

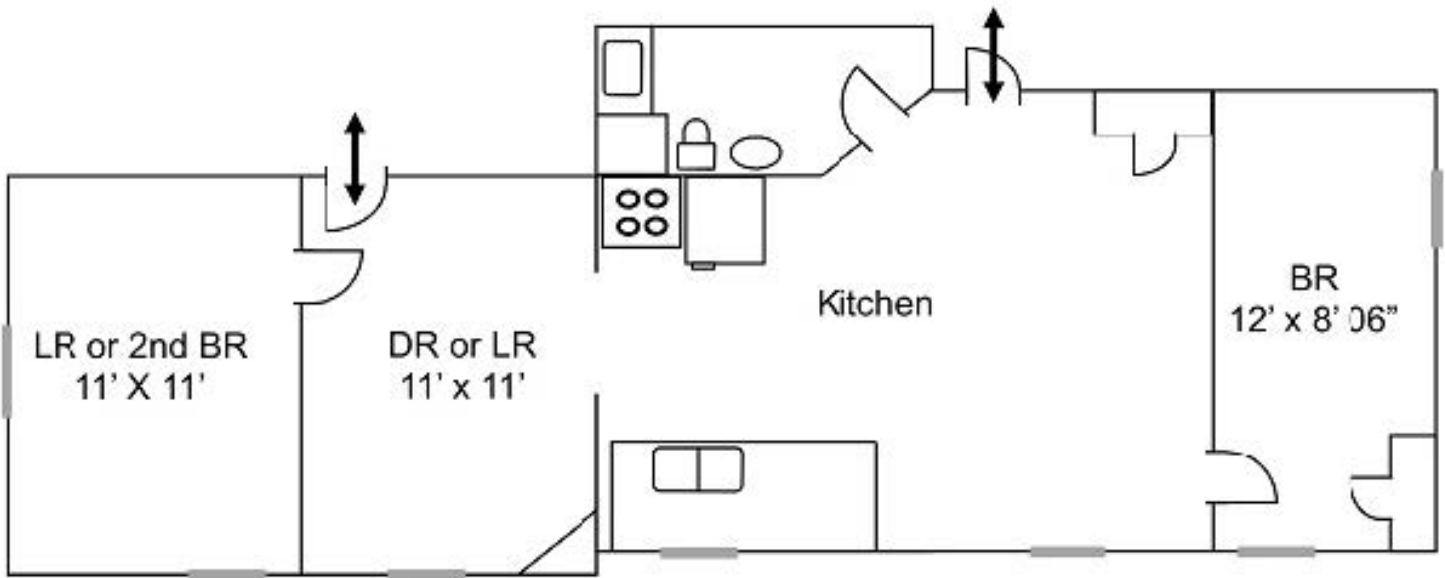

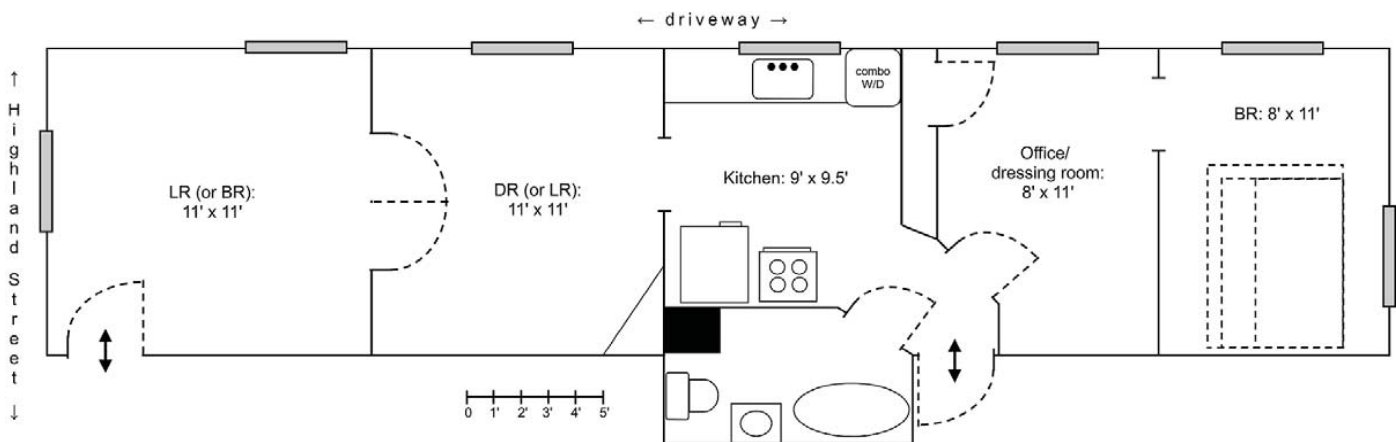
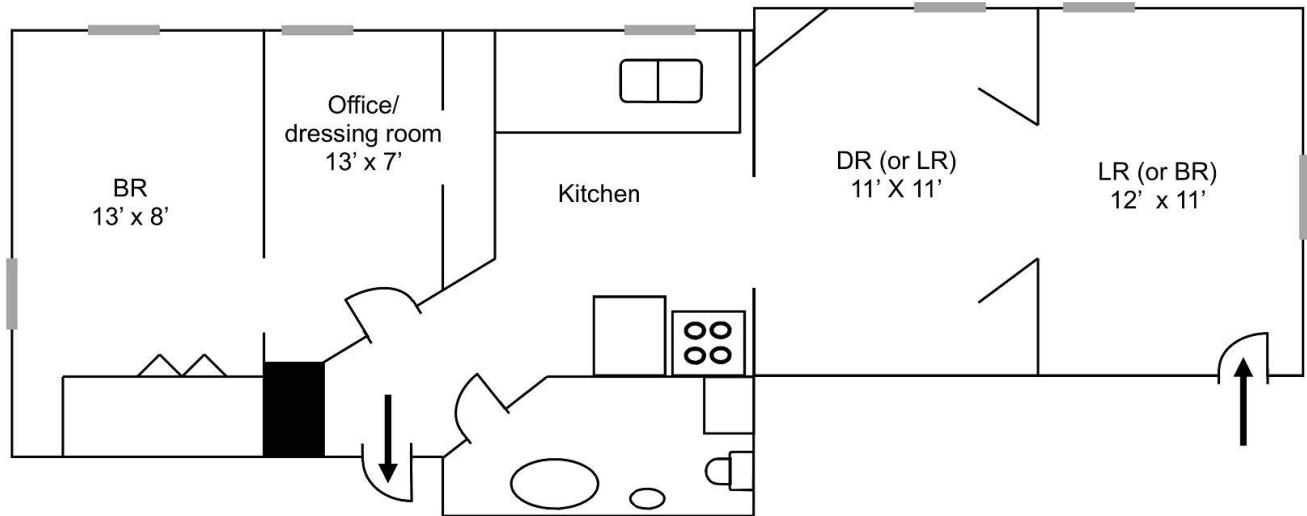
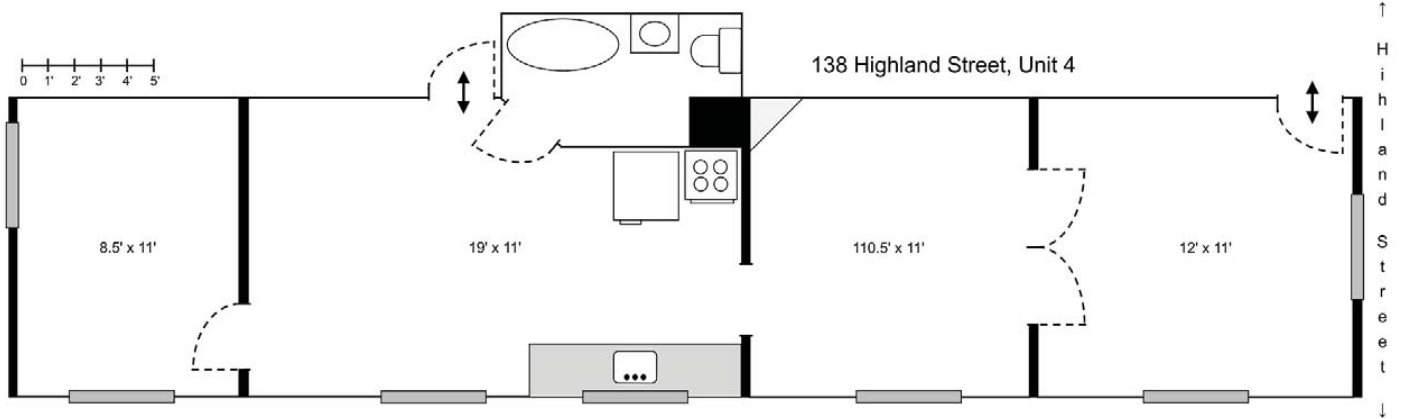



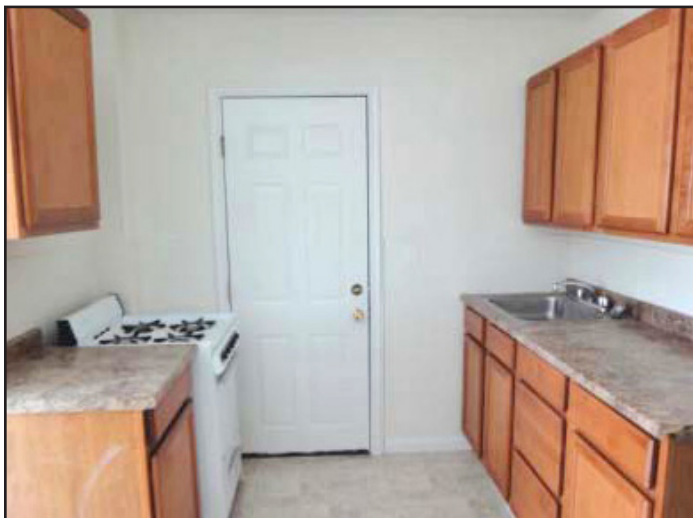
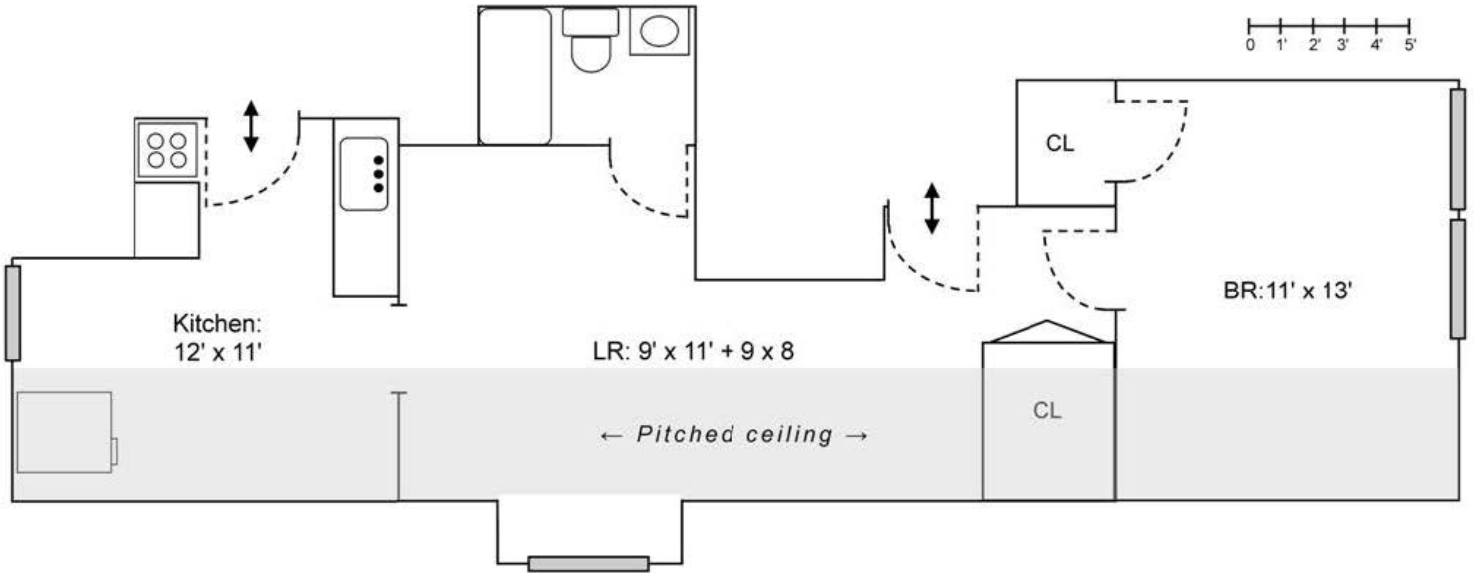

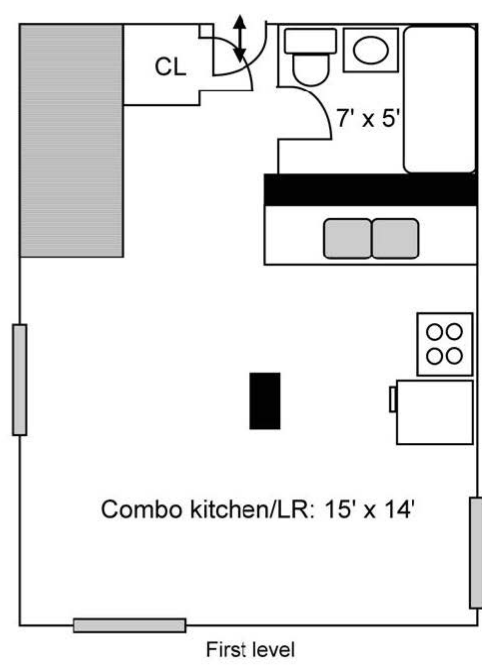
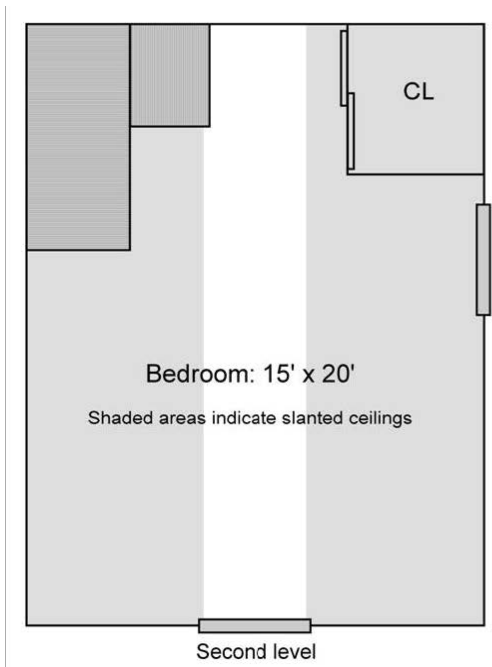
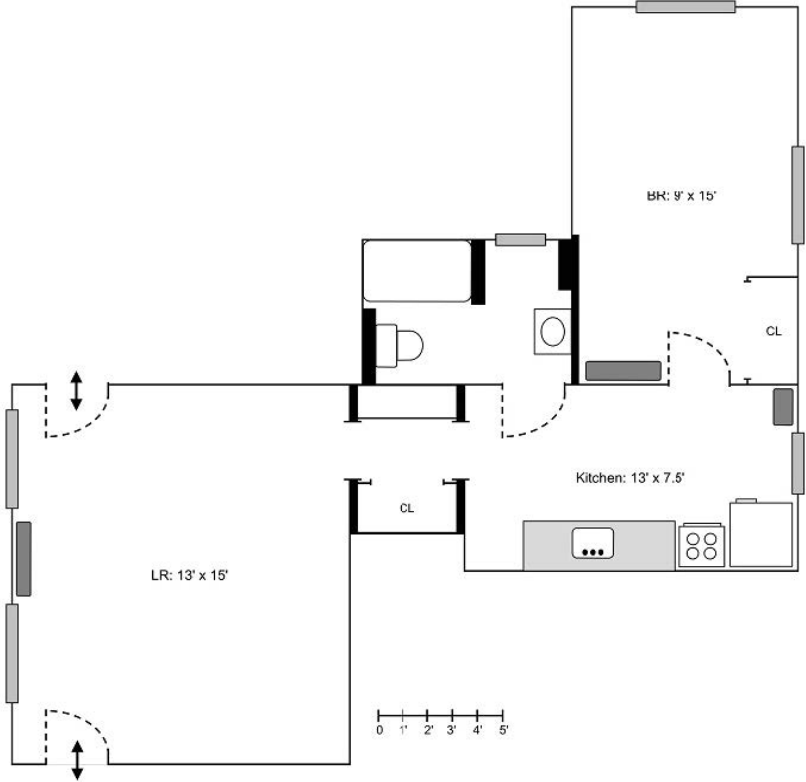
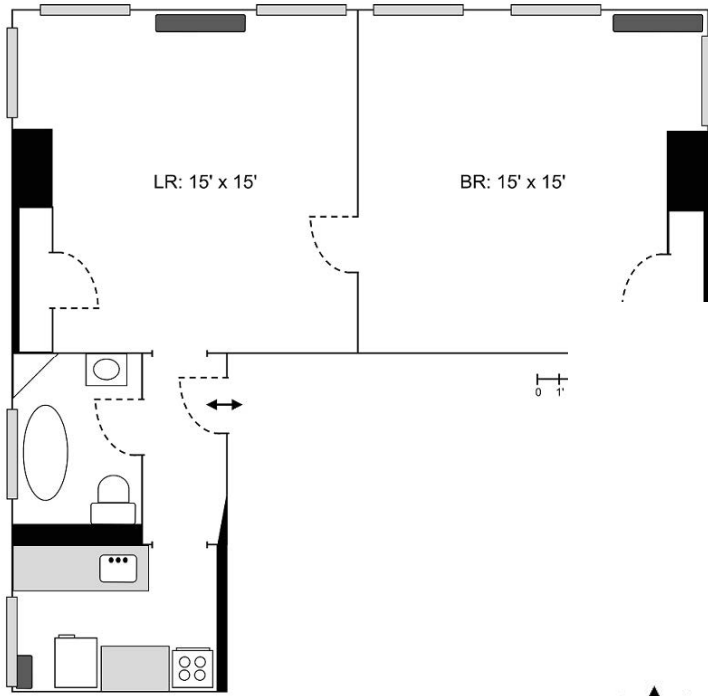



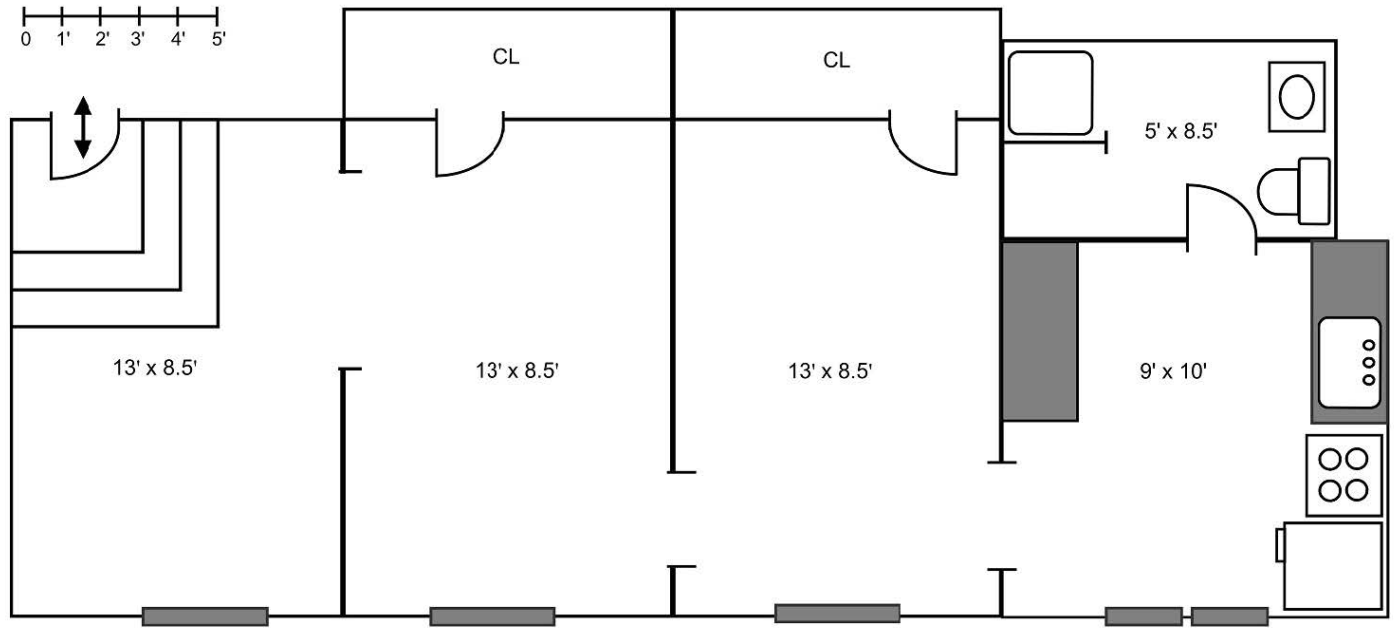

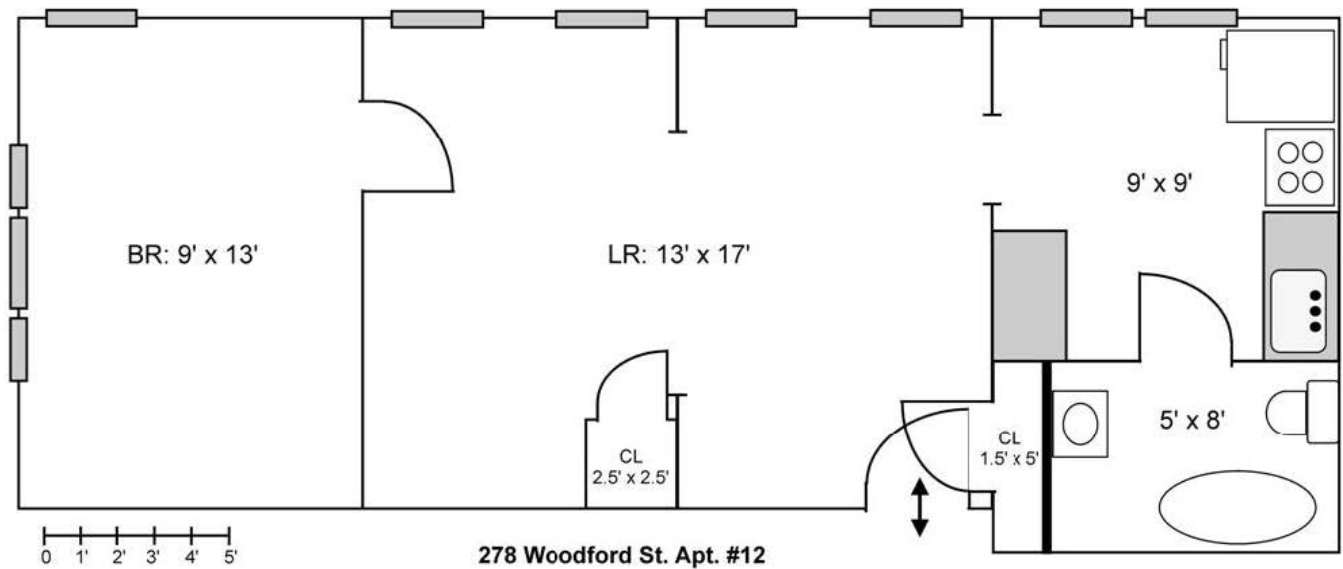
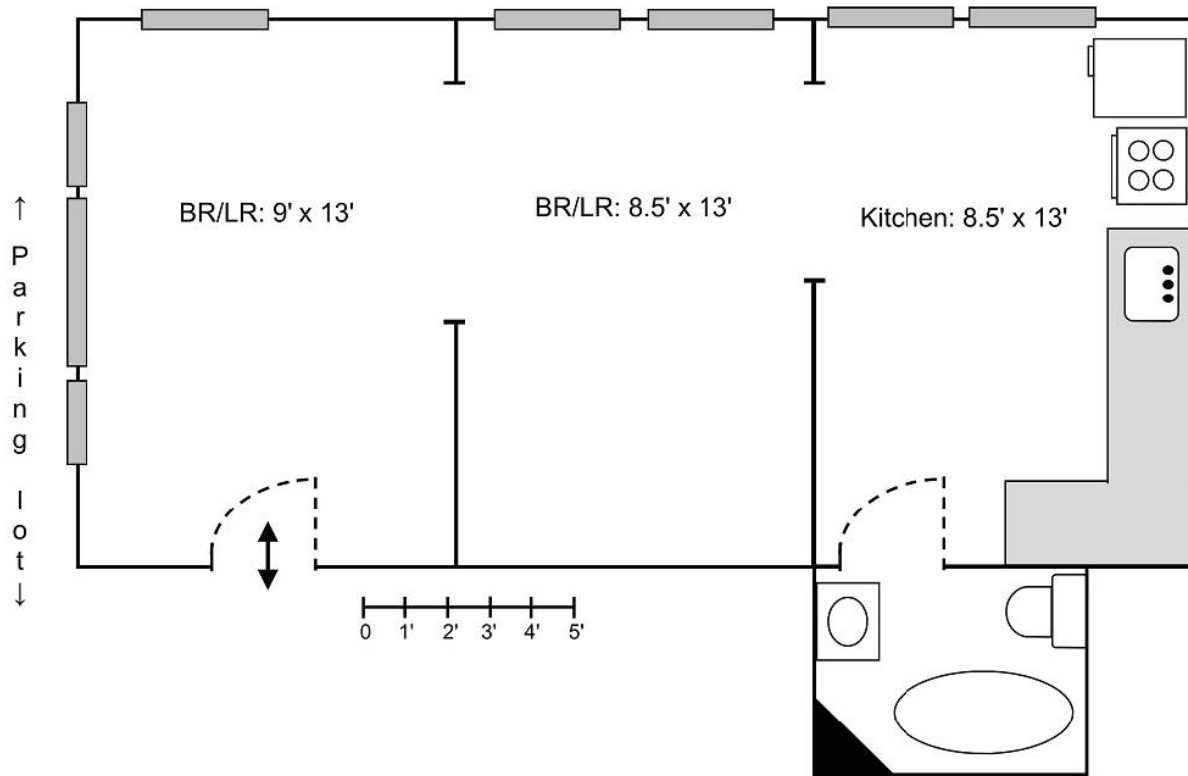

278 Woodford St. Apt. #12

The information contained herein has been given to us by the owner of the property or other sources we deem reliable. We have no reason to doubt its accuracy, but we do not guarantee it. All information should be verified prior to purchase or lease.



Dept. of Professional & Financial Regulation  
Office of Professional & Occupational Regulation  
**MAINE REAL ESTATE COMMISSION**

35 State House Station Augusta ME 04333-0035



## REAL ESTATE BROKERAGE RELATIONSHIPS FORM

### *Right Now You Are A Customer*

Are you interested in buying or selling residential real estate in Maine? Before you begin working with a real estate licensee it is important for you to understand that Maine Law provides for different levels of brokerage service to buyers and sellers. You should decide whether you want to be represented in

a transaction (as a client) or not (as a customer). To assist you in deciding which option is in your best interest, please review the following information about real estate brokerage relationships:

Maine law requires all real estate brokerage companies and their affiliated licensees ("licensee") to perform certain basic duties when dealing with a buyer or seller. You can expect a real estate licensee you deal with to provide the following **customer-level services**:

- ✓ To disclose all material defects pertaining to the physical condition of the real estate that are known by the licensee;
- ✓ To treat both the buyer and seller honestly and not knowingly give false information;
- ✓ To account for all money and property received from or on behalf of the buyer or seller; and
- ✓ To comply with all state and federal laws related to real estate brokerage activity.

Until you enter into a written brokerage agreement with the licensee for client-level representation you are considered a "customer" and the licensee is not your agent. **As a customer, you should not expect the licensee to promote your best interest, or to keep any information you give to the licensee confidential, including your bargaining position.**

### *You May Become A Client*

If you want a licensee to represent you, you will need to enter into a written listing agreement or a written buyer representation agreement. These agreements **create a client-agent relationship** between you and the licensee. As a client you can expect the licensee to provide the following services, **in addition** to the basic services required of all licensees listed above:

- ✓ To perform the terms of the written agreement with skill and care;
- ✓ To promote your best interests;
  - For seller clients this means the agent will put the seller's interests first and negotiate the best price and terms for the seller;
  - For buyer clients this means the agent will put the buyer's interests first and negotiate for the best prices and terms for the buyer; and
- ✓ To maintain the confidentiality of specific client information, including bargaining information.

### **COMPANY POLICY ON CLIENT-LEVEL SERVICES — WHAT YOU NEED TO KNOW**

The real estate brokerage company's policy on client-level services determines which of the three types of agent-client relationships permitted in Maine may be offered to you. The agent-client relationships permitted in Maine are as follows:

- ✓ The company and all of its affiliated licensees represent you as a client (called "**single agency**");
- ✓ The company appoints, with your written consent, one or more of the affiliated licensees to represent you as an agent(s) (called "**appointed agency**");
- ✓ The company may offer limited agent level services as a **disclosed dual agent**.

#### **WHAT IS A DISCLOSED DUAL AGENT?**

In certain situations a licensee may act as an agent for and represent both the buyer and the seller in the same transaction. This is called **disclosed dual agency**. *Both the buyer and the seller must consent to this type of representation in writing.*

Working with a dual agent is not the same as having your own exclusive agent as a single or appointed agent. For instance, when representing both a buyer and a seller, the dual agent must not disclose to one party any confidential information obtained from the other party.

***Remember!***  
*Unless you enter into a written agreement for agency representation, you are a customer—not a client.*

#### **THIS IS NOT A CONTRACT**

It is important for you to know that this form is not a contract. The licensee's completion of the statement below acknowledges that you have been given the information required by Maine law regarding brokerage relationships so that you may make an informed decision as to the relationship you wish to establish with the licensee/company.

*To Be Completed By Licensee*

This form was presented on (date) \_\_\_\_\_

To \_\_\_\_\_  
Name of Buyer(s) or Seller(s)

by \_\_\_\_\_  
Licensee's Name

on behalf of \_\_\_\_\_  
Company/Agency

MREC Form#3 Revised 07/2006  
Office Title Changed 09/2011

*To check on the license status of the real estate brokerage company or affiliated licensee go to [www.maine.gov/professionallicensing](http://www.maine.gov/professionallicensing). Inactive licensees may not practice real estate brokerage.*